

## SPECIFICATIONS

### RESOLUTION

Pixels used for picture taking .....480 (V) x 180 (H) pixels  
 Capturing scope .....0.25 x 0.54 mm  
 1 centre + 12 peripheral measurements .....15 x fixation points  
 Min. cell resolution .....1.14 µm (V) x 1.45 µm (H)  
 Optical magnification.....x 190  
 Display .....10.4" LCD Colour  
 Display resolution.....1.14 µm

### MEASUREMENT

Auto alignment.....Yes  
 Auto measurement .....Yes  
 Manual mode (1 & 2).....Yes

### MEASUREMENT FUNCTION

Automated captured examination.....16 pictures for analysis  
 Number of analysed cells .....Up to 300 cells  
 Capturing position .....Center + 12 peripheral points  
 Analysis method Automatic analysis, L-count, Core method, Dark area method  
 Analysis values .....CD (cell density)  
 AVG (average cell area)  
 SD (standard deviation of cell area)  
 CV (coefficient of variation of cell area)  
 Cell size (max. + min. cell area)

Stroke of moving section ..... X: 88 mm, Y: 40 mm, Z: 50 mm  
 Stroke of electrical chin rest.....70 mm  
 Measuring accuracy Pachymetry .....+/- 10 µm

### OPERATING ENVIRONMENT

Temperature .....+10° to +40°  
 Humidity.....30 % to 75 %  
 Atmospheric pressure .....800 to 1060 hPa  
 Standards applied .....MDD Annex ii, iSo 13485

### DATA MANAGEMENT

Built-in printer.....Thermal printer  
 Data output type .....USB-Hx2, USB-Dx2, LAN, SD Card (for internal database)

### DIMENSIONS & ELECTRIC REQUIREMENTS

Dimensions WDH.....309 x 491 x 450 mm  
 Weight .....Approx. 22 kg  
 Voltage .....AC 100 to 240 V  
 Frequency .....50/60 Hz  
 Power consumption .....100 VA

#### Dimensions

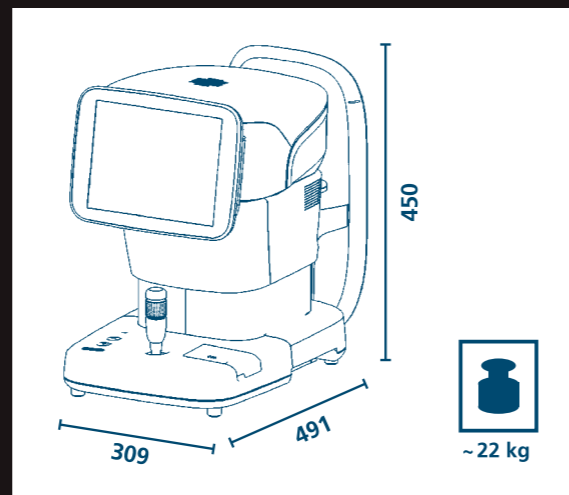

#### Wide capturing areas including peripheral

Different fixation targets enable you to capture images also in the periphery – 13 different areas in total! The wide range of positions increases the chance of capturing images on patients with partial cornea opacity.

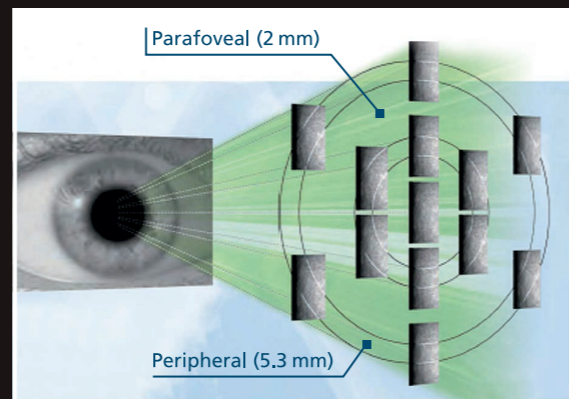

2018/09 - subject to change without notice

## ENDOTHELIUM MICROSCOPE REM 4000

# PLUG & TOUCH BY RODENSTOCK

Stand alone, fast and easy handling.

- Auto alignment + auto measurement
- Integrated non contact Pachymetry
- 13 measurement areas
- Integrated database and printer
- Automatic analysis, L-count, Core method, Dark area method
- Counts up to 300 cells
- Extremely fast



#### RODENSTOCK Instruments

Wiesbadener Straße 21, 90427 Nürnberg, Germany  
 Phone +49 911 938 546 2 777, Fax +49 911 938 546 2 20  
 info@rodenstock-instruments.de, www.rodenstock-instruments.de  
 Rodenstock Instruments is a business unit of Tomey GmbH.

RODENSTOCK Instruments. In touch with your needs.





# QUALITY IN DETAIL

Non-contact examination, auto alignment and measurement plus automatic analysis of the endothelium layer make working with the REM 4000 professional and quick (4 sec. for both eyes). Thanks to our auto alignment technology we can assure the reproducibility of the measured area and therefore also the analysed values.

The integrated non-contact Pachymetry will be automatically measured with every central examination. The big colour touch screen is used as an operating monitor as well as for displaying all measured values. All commands can be given via touch screen.

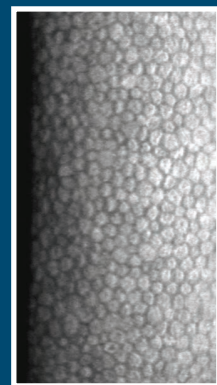

Endothelium layer

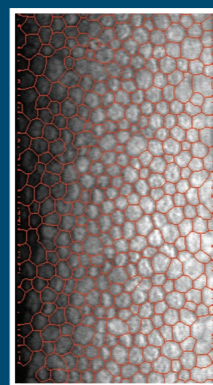

Traced image

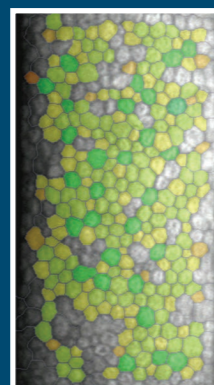

Different sizes displayed in colours



Polygonal shapes displayed in colours

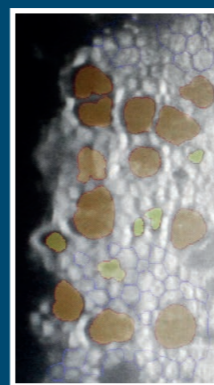

Dark area analysis

## Database function & built-in printer

A database function is provided in the main unit. Two selected measurements can be displayed simultaneously, allowing you to compare observations before and after surgery for the same patient. Data for approx. 16,000 patients can be stored in the SD card set in the main unit.

Performing reanalysis using a different analysis method is possible by retrieving data which has been stored. Print-out displays the endothelium image and the analysis result.



Integrated database

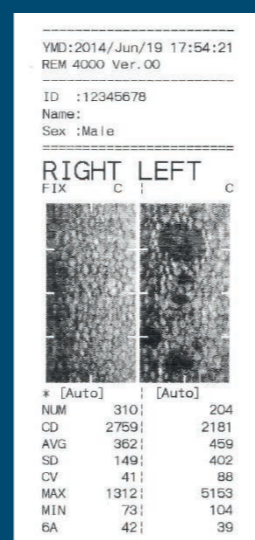

Built-in printer

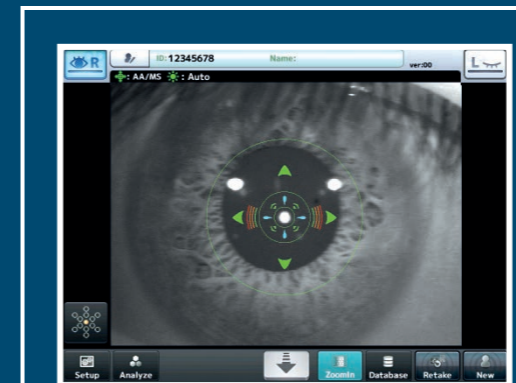
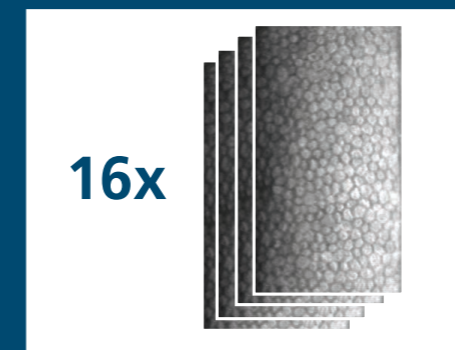
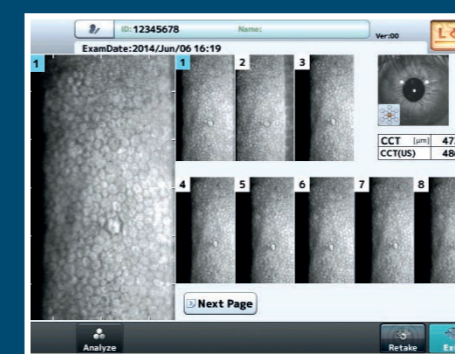

Image is taken automatically



Automated capturing of 16 images



Best image

## Fast and fully automated analysis of corneal endothelium cells

The software evaluates all relevant data respective to the endothelium, such as the density of cells as well as Polymegathism and Pleomorphism (morphology). High-quality images enable discovering irregularities or possible degeneration of the endothelium. For these difficult cases you can use the classical L-count function, the Core method and our special dark area analysis tool.

## Auto alignment + auto measurement

The handling of the REM 4000 is very easy – it does almost everything by itself. Alignment and measurement are done automatically. Of course you also can do the examination in the manual mode.

## 13 measurement areas + automatic Pachymetry

The REM 4000 has a very large measurement area. With up to 300 counted cells the system assures a representative cell density analysis of your patients' cornea. Images can be taken at 13 positions: the centre and 12 peripheral points. Additional to that the thickness of the cornea will be automatically measured with every central exam – of course in non contact method.

## Choose between automatic or manual analysis

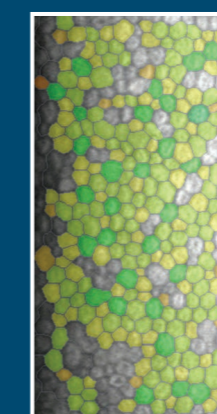

Trace method

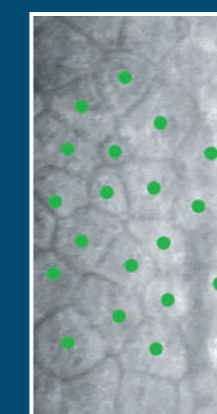

Core method

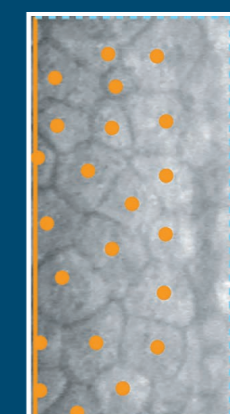

L-count method